

CANALIZZAZIONE PER PIANI ACCESS PLATE

exitfly

passaggio cavi per piani
flip-top access plate

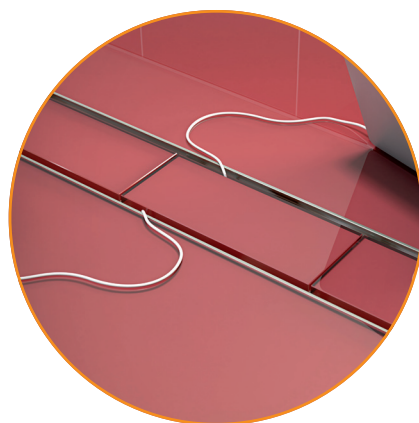





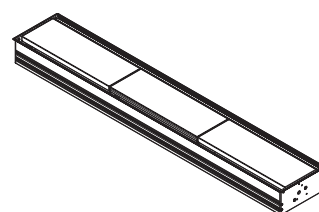

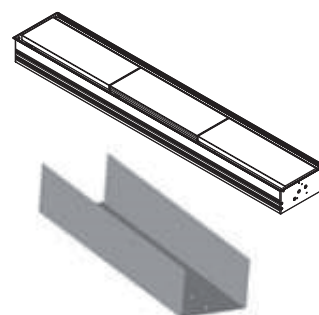

Exit fly

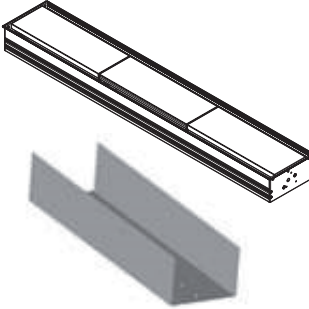
EXIT FLY DUAL SENZA VASCA EXIT FLY DUAL KIT WITHOUT CABLE TRUNK					
CODICE CODE	1 COPERCHI COVERS L 300 mm	alluminio anodizzato anodized aluminum	040.030.00001	PREZZO PRICE	
		acciaio brillante shiny steel	040.030.00002		
		alluminio grezzo raw aluminum	040.030.00003		
	2 COPERCHI COVERS L 600 mm	alluminio anodizzato anodized aluminum	040.030.00004	PREZZO PRICE	
		acciaio brillante shiny steel	040.030.00005		
		alluminio grezzo raw aluminum	040.030.00006		
	3 COPERCHI COVERS L 900 mm	alluminio anodizzato anodized aluminum	040.030.00007	PREZZO PRICE	
		acciaio brillante shiny steel	040.030.00008		
		alluminio grezzo raw aluminum	040.030.00009		
	4 COPERCHI COVERS L 1204 mm	alluminio anodizzato anodized aluminum	040.030.00010	PREZZO PRICE	
		acciaio brillante shiny steel	040.030.00011		
		alluminio grezzo raw aluminum	040.030.00012		
	5 COPERCHI COVERS L 1502 mm	alluminio anodizzato anodized aluminum	040.030.00013	PREZZO PRICE	
		acciaio brillante shiny steel	040.030.00014		
		alluminio grezzo raw aluminum	040.030.00015		
	6 COPERCHI COVERS L 1800 mm	alluminio anodizzato anodized aluminum	040.030.00016	PREZZO PRICE	
		acciaio brillante shiny steel	040.030.00017		
		alluminio grezzo raw aluminum	040.030.00018		
EXIT FLY DUAL CON VASCA EXIT FLY DUAL KIT WITH CABLE TRUNK					
CODICE CODE	1 COPERCHI COVERS L 300 mm	alluminio anodizzato anodized aluminum	040.030.00019	PREZZO PRICE	
		acciaio brillante shiny steel	040.030.00020		
		alluminio grezzo raw aluminum	040.030.00021		
	2 COPERCHI COVERS L 600 mm	alluminio anodizzato anodized aluminum	040.030.00022	PREZZO PRICE	
		acciaio brillante shiny steel	040.030.00023		
		alluminio grezzo raw aluminum	040.030.00024		
	3 COPERCHI COVERS L 900 mm	alluminio anodizzato anodized aluminum	040.030.00025	PREZZO PRICE	
		acciaio brillante shiny steel	040.030.00026		
		alluminio grezzo raw aluminum	040.030.00027		

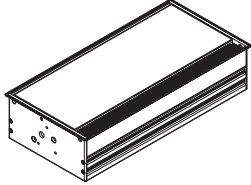

exitfly



CODICE CODE	4 COPERCHI COVERS L 1204 mm	alluminio anodizzato anodized aluminum	040.030.00028	PREZZO PRICE		
		acciaio brillante shiny steel	040.030.00029			
		alluminio grezzo raw aluminum	040.030.00030			
	5 COPERCHI COVERS L 1502 mm	alluminio anodizzato anodized aluminum	040.030.00031	PREZZO PRICE		
		acciaio brillante shiny steel	040.030.00032			
		alluminio grezzo raw aluminum	040.030.00033			
	6 COPERCHI COVERS L 1800 mm	alluminio anodizzato anodized aluminum	040.030.00034	PREZZO PRICE		
		acciaio brillante shiny steel	040.030.00035			
		alluminio grezzo raw aluminum	040.030.00036			
NOTE NOTES						
DIM. L x H x W 37 x 23 x 20 cm 152 x 24 x 12 cm 136 x 23 x 11 cm 174 x 23 x 11 cm			PESO WEIGHT 1,3 kg 4,2 kg 3,9 kg 4,9 kg	PEZZI PER SCATOLA PCS PER BOX 1 MOQ 1 PZ / PCS	CODICE DOGANALE CUSTOM CODE 83024200	
Coperchi non inclusi Covers not included		 				
EXIT FLY MONO SENZA VASCA EXIT FLY MONO KIT WITHOUT CABLE TRUNK						
CODICE CODE	1 COPERCHI COVERS L 300 mm	alluminio anodizzato anodized aluminum	040.031.00001	PREZZO PRICE		
		acciaio brillante shiny steel	040.031.00002			
		alluminio grezzo raw aluminum	040.031.00003			
NOTE NOTES						
DIM. L x H x W 37 x 23 x 20 cm			PESO WEIGHT 1,0 kg	PEZZI PER SCATOLA PCS PER BOX 1 MOQ 1 PZ / PCS	CODICE DOGANALE CUSTOM CODE 83024200	
Coperchi non inclusi Covers not included		 				
VASCA PER EXIT FLY CABLE TRUNK FOR EXIT FLY						
CODICE CODE	1 VASCA CABLE TRUNK L 300 mm	alluminio aluminum	530.010.00088	PREZZO PRICE	€ 27,00	
		nero black	530.010.00089		€ 27,00	
		grezzo raw	530.010.00176		€ 27,00	



asa cable

exitfly

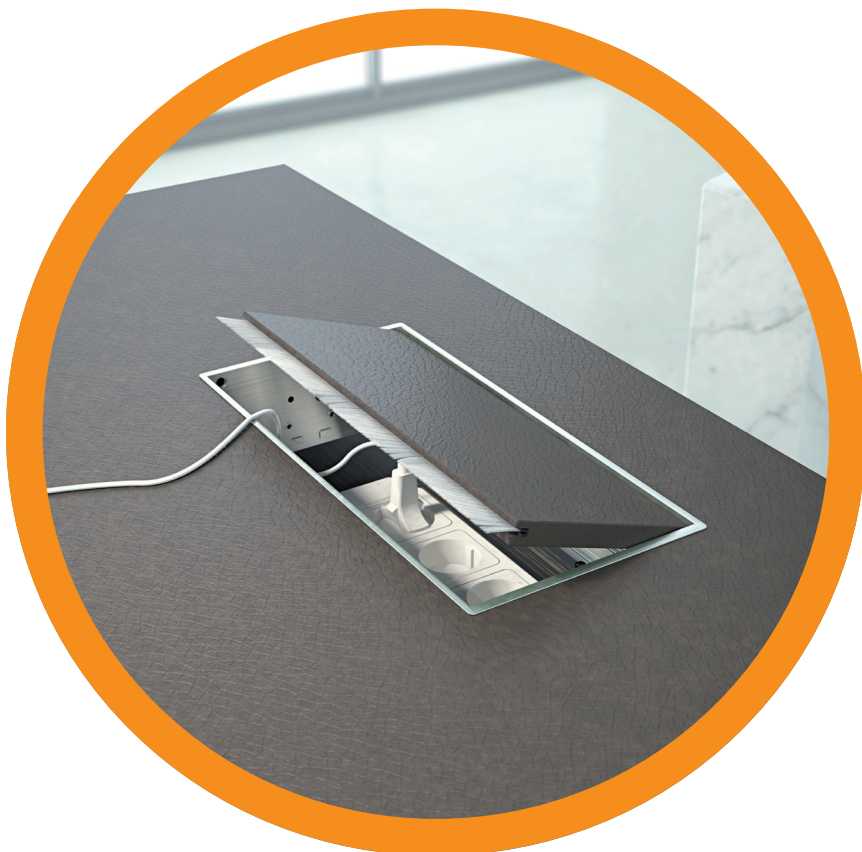

SCHEMA TECNICA/ DATA SHEET

ED.3 24.03.2021

Exit Fly Dual

Passaggio cavi per piani scrivania
Flip-top access plate

Exit Fly Dual consente la canalizzazione sui piani di lavoro, di bench e meeting table in varie dimensioni e finiture. Il pannello centrale ruota manualmente in entrambe le direzioni. L'ammortizzatore soft close accompagna il coperchio in fase di chiusura.

Exit Fly Dual allows the cable management on the worktop, bench systems and meeting tables in different sizes & finishes. The central cover rotates manually in both directions. The installed mechanism allows a nice soft closing.

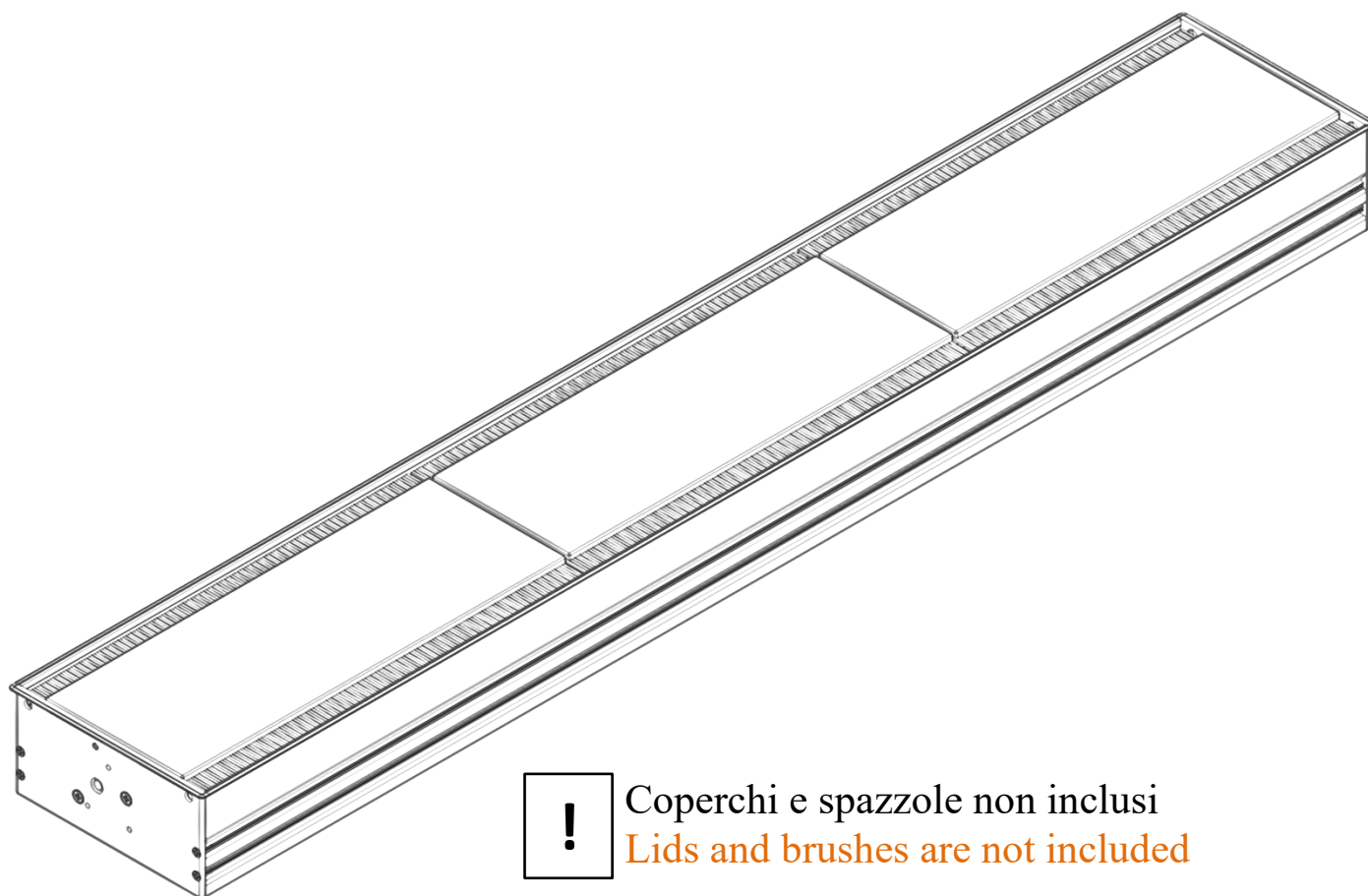

Coperchi e spazzole non inclusi
Lids and brushes are not included

Dati commerciali / Commercial data

Codice prodotto/Product code: ...

N° Disegno/ Drawing N°: ...

Descrizione/Description: Passacavo con doppia apertura / Cable management with dual side opening system

SCHEMA TECNICA/ DATA SHEET

Exit Fly Dual

Dati tecnici/Technical data

Materiali/Materials

Tappi terminali <i>End caps</i>	Zama
------------------------------------	------

Profili <i>Side profiles</i>	Alluminio <i>Aluminum</i>
---------------------------------	------------------------------

Dimensioni/Dimensions

Lunghezze (mm) <i>Lengths (mm)</i>	310 - 608 - 906 - 1204 - 1502 - 1800
---------------------------------------	--------------------------------------

Larghezza (mm) <i>Width (mm)</i>	150
-------------------------------------	-----

Altezza (mm) <i>Height (mm)</i>	71
------------------------------------	----

Spessore piano (mm) <i>Plane Thickness (mm)</i>	12 ÷ 70
--	---------

Finiture/Finishes

Struttura <i>Structure</i>		Alluminio anodizzato <i>Anodized aluminum</i>
-------------------------------	---	--



		Acciaio brillante <i>Shiny steel</i>
--	--	---



		Alluminio grezzo <i>Raw aluminum</i>
--	--	---

Note/Notes

- Disponibili a richiesta altre finiture e dimensioni
- *Other finishes and sizes available upon request*

Tutte le dimensioni indicate sono nominali. I disegni e le immagini sono solo a scopo illustrativo. I dettagli del prodotto e le dimensioni sono soggetti a modifiche senza preavviso.

All dimensions quoted are nominal only. Drawings and images are for illustrative purposes only. All product dimensions and specifications are subject to change without notice.

Contatti/Contacts

A.S.A. Plastici S.r.l

Via Buonarroti, 60

20090 Trezzano S/N (MI) Italy

Tel/Phone +39024455894 Fax +39024450107

Website: www.asaplastici.it E-mail: info@asaplastici.it

Cod.Fisc. P.IVA IT02526270158

