

# BUSTER+PUNCH

LONDON

**GIRDER SHELF**  
PREPARATION AND INSTALLATION  
INSTRUCTION MANUAL

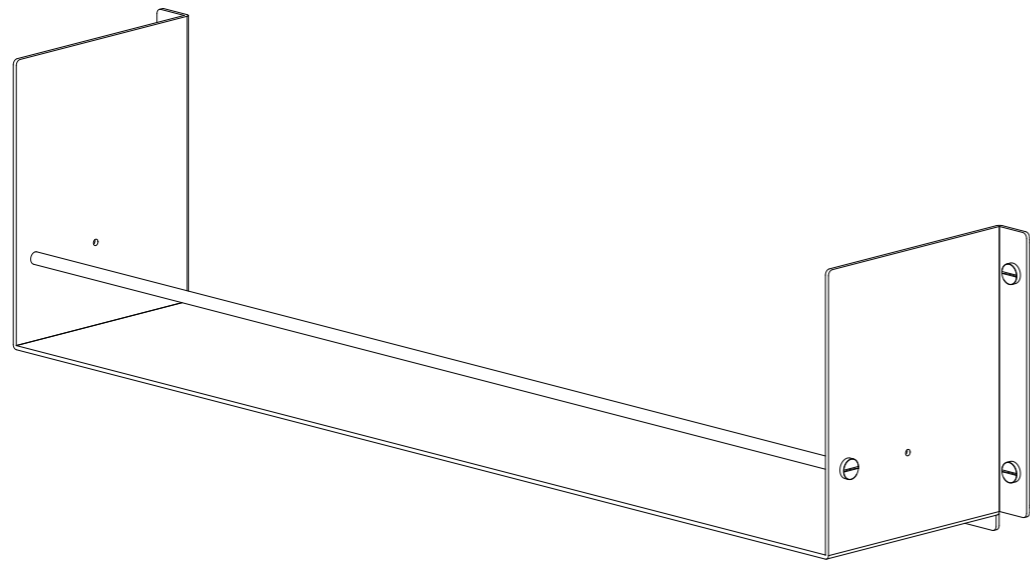

**DETAILS KIT**  
**CONTENTS**

NOT  
INCLUDED



x8



x6



x2

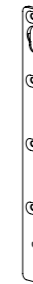

x2

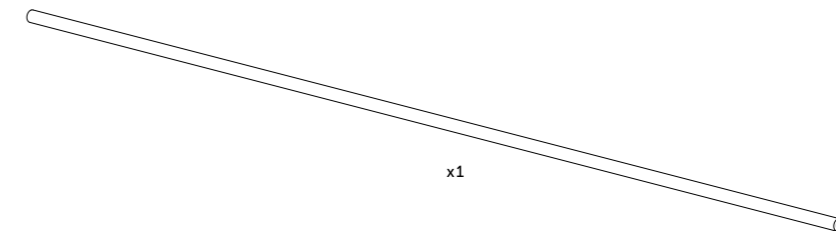

x1

# 1

Locate the glass rail in the position that is desired, and use two coin screws to fix it in place

Ensure the screws are not cross-threaded

Use fingers only, no screw drivers

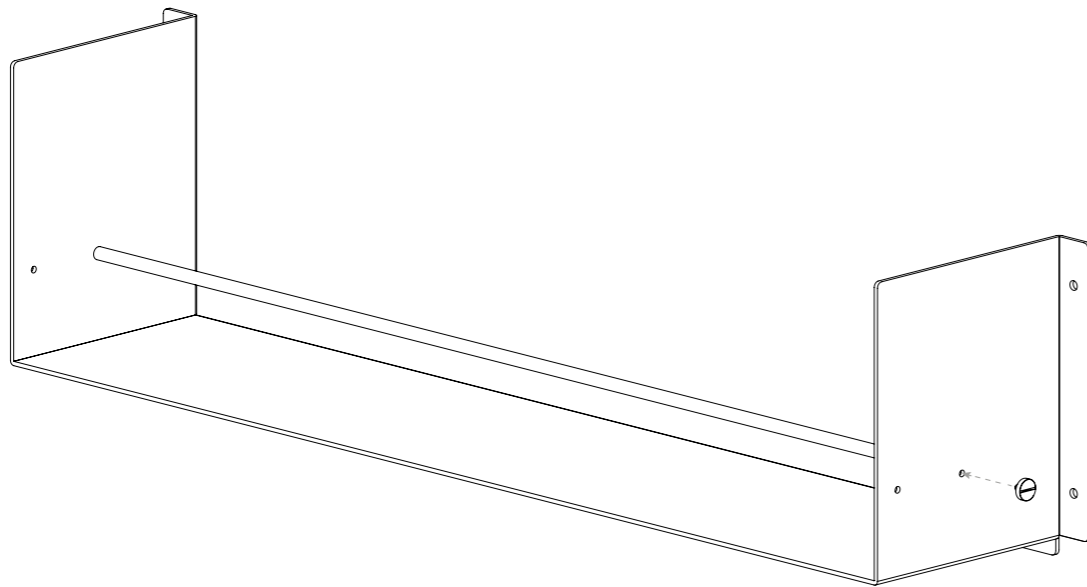
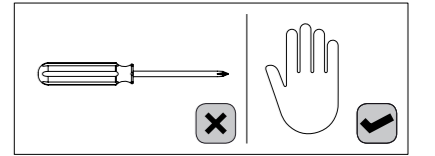

or

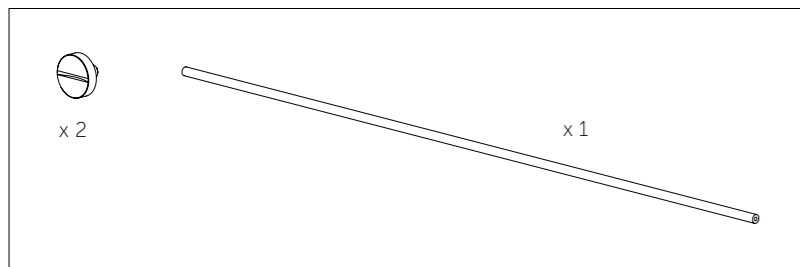
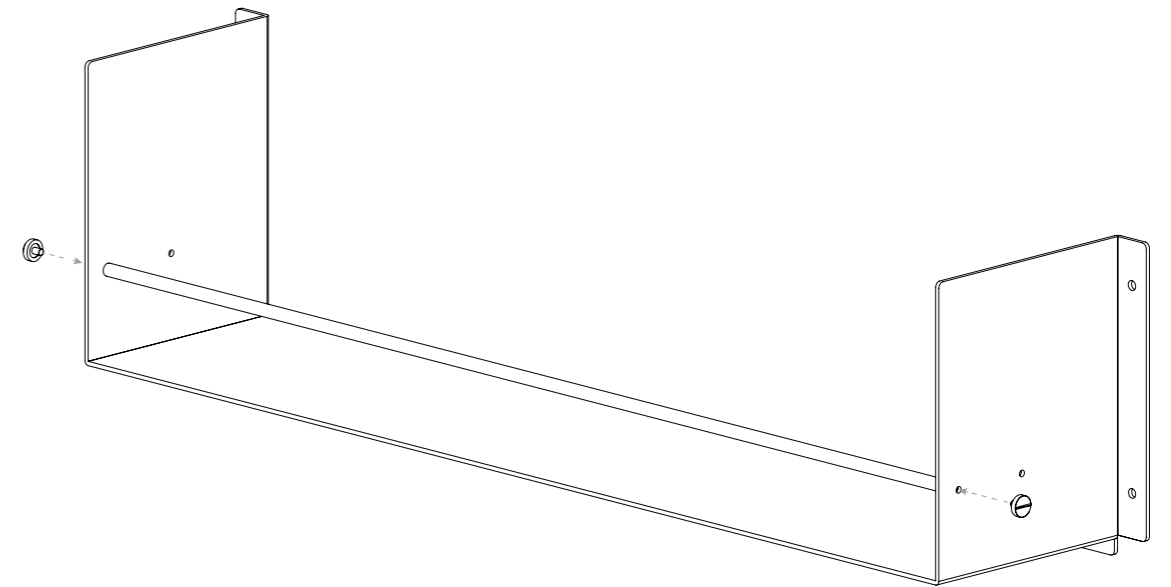

2

**a.** Hold the shelf up to the wall, marking two points through the top holes, centre-distance 1094mm

Ensure that the shelf is level before marking

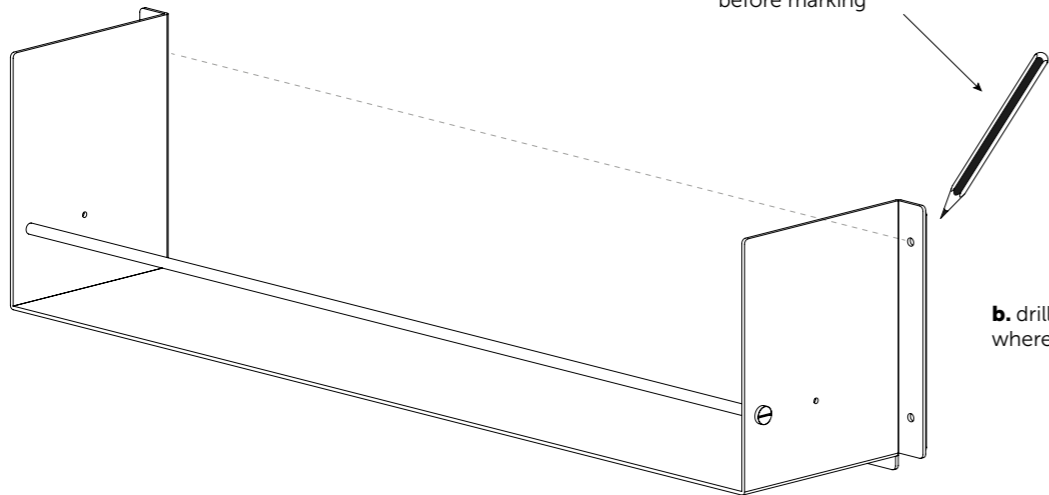

**b.** drill two 2mm pilot holes where the marks are

Consult this diagram to determine the height your shelf will sit on the wall

Bracket mounting screw position

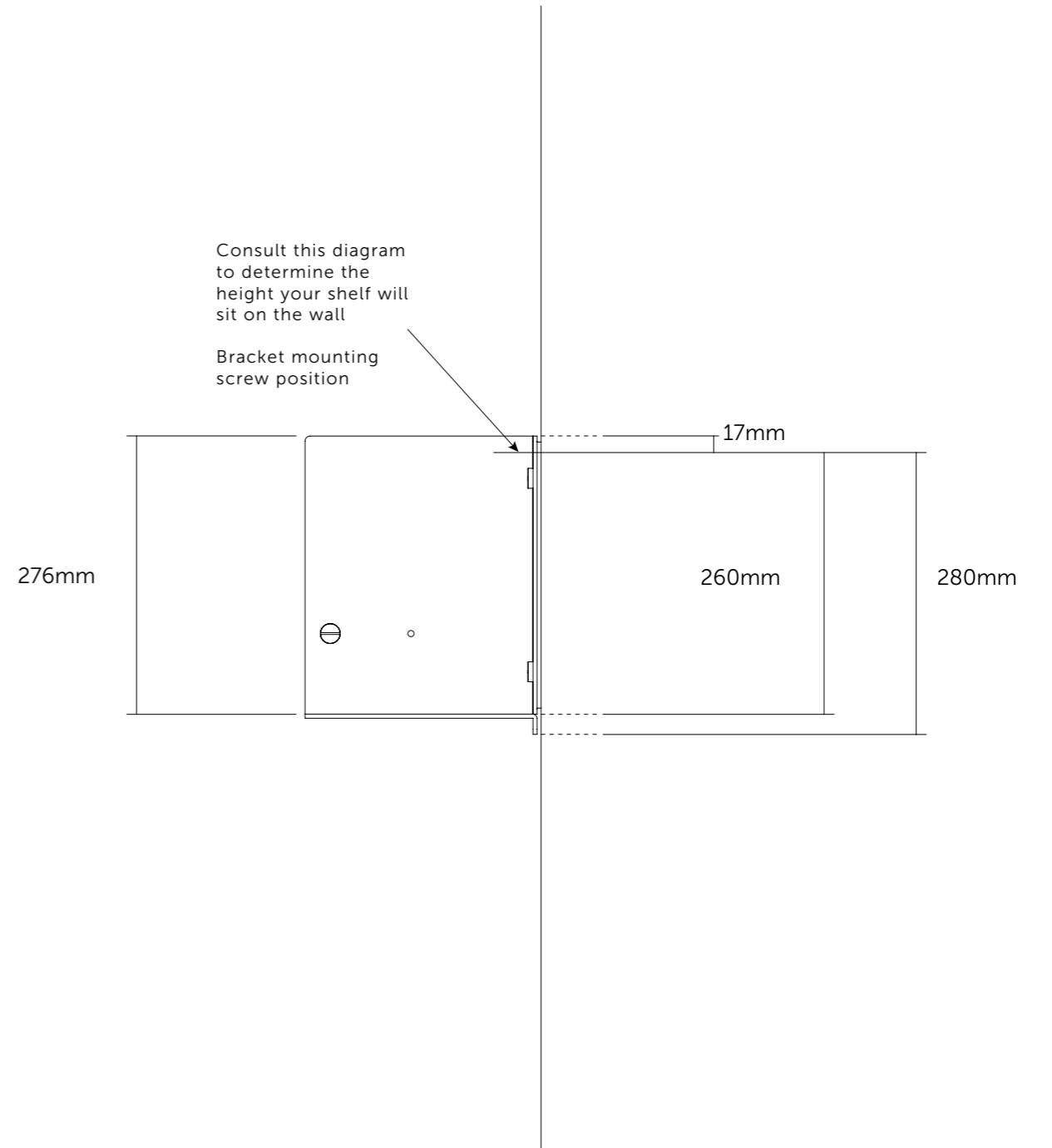

3

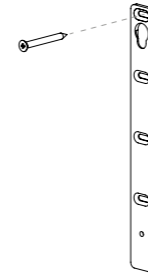
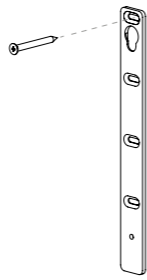
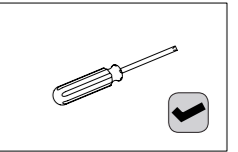

**a.** Screw in two screws in the top mounting holes on both brackets

Do not fully tighten down

Make sure the brackets are vertical

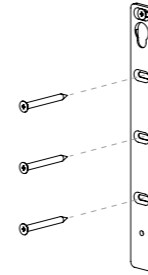
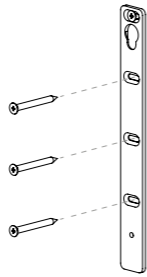

**b.** Secure brackets by adding the remaining six screws

Ensure the brackets are hanging vertically before tightening screws

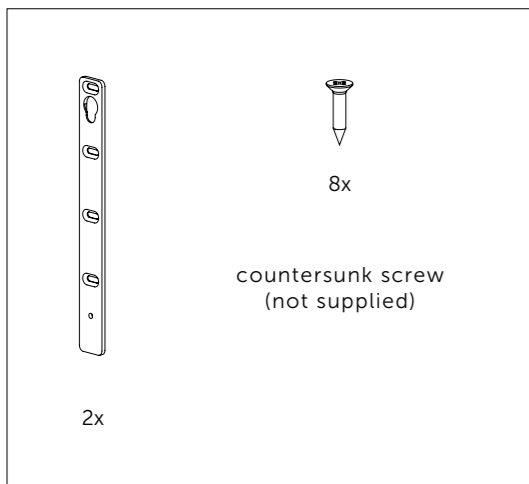

4

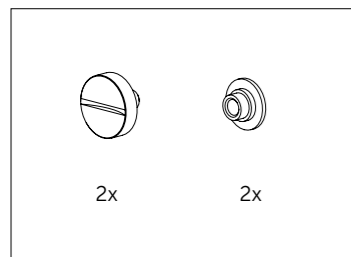
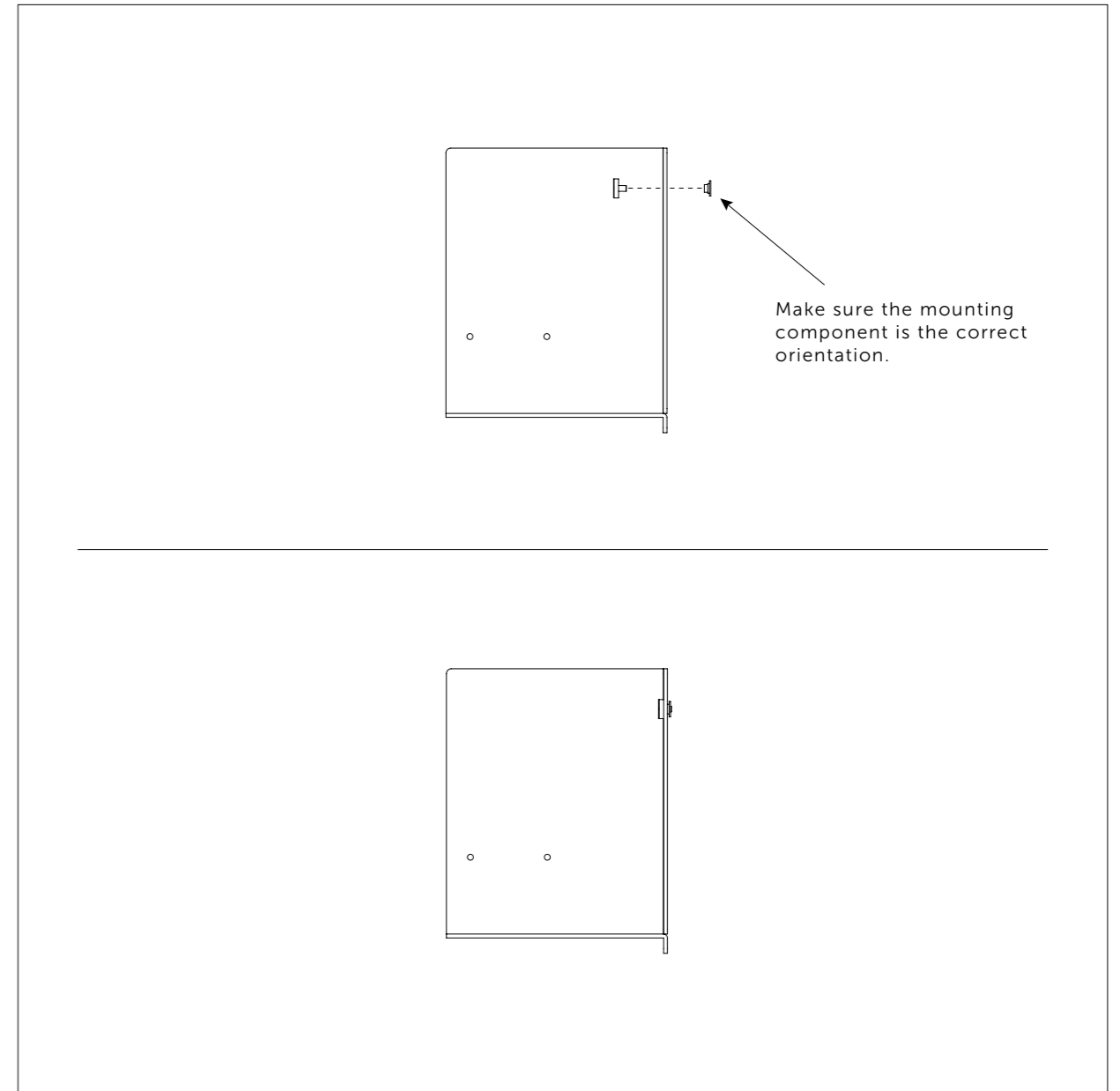
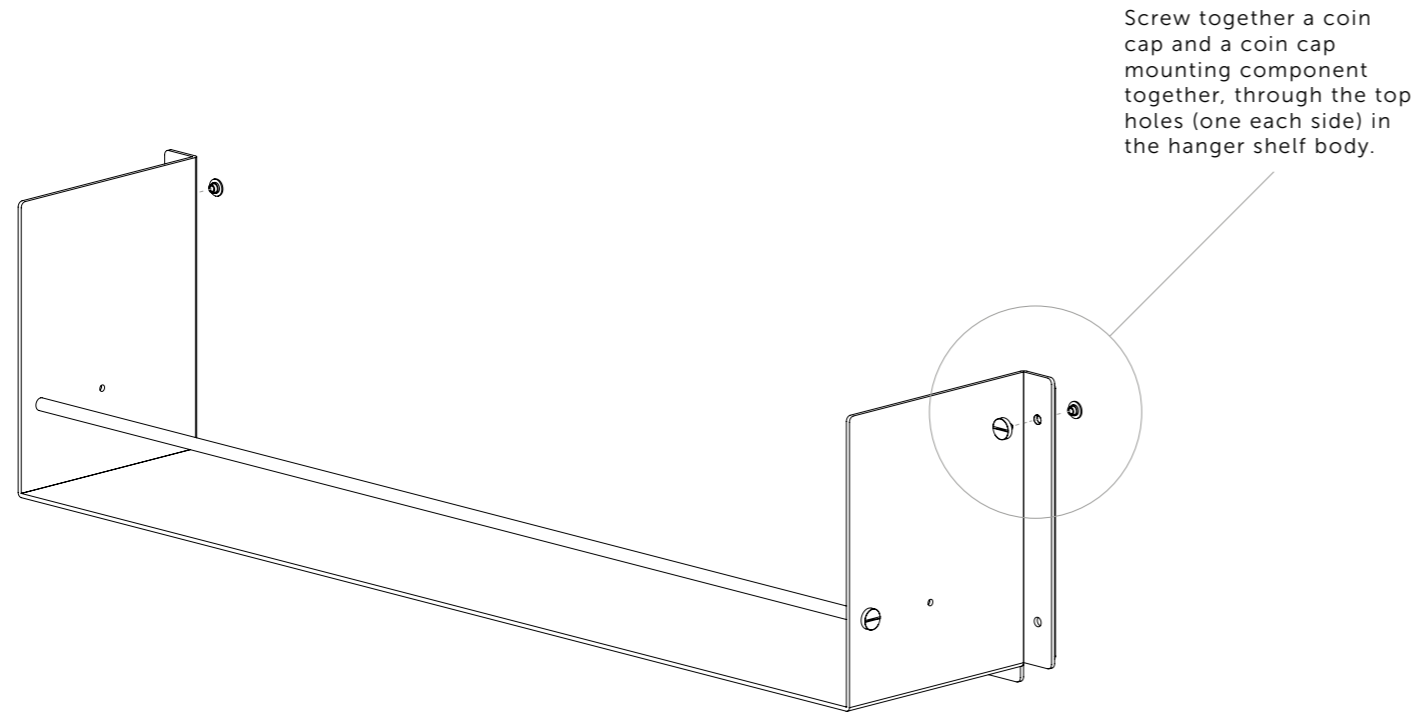
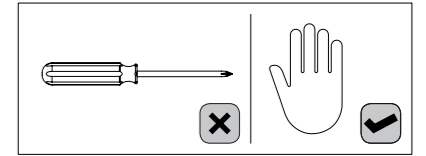

Hang the shelf on the brackets.  
Use the coin screw connector and slot the shelf into the brackets.  
Once the connector is in the hole, the shelf should drop down into the slot on the bracket.

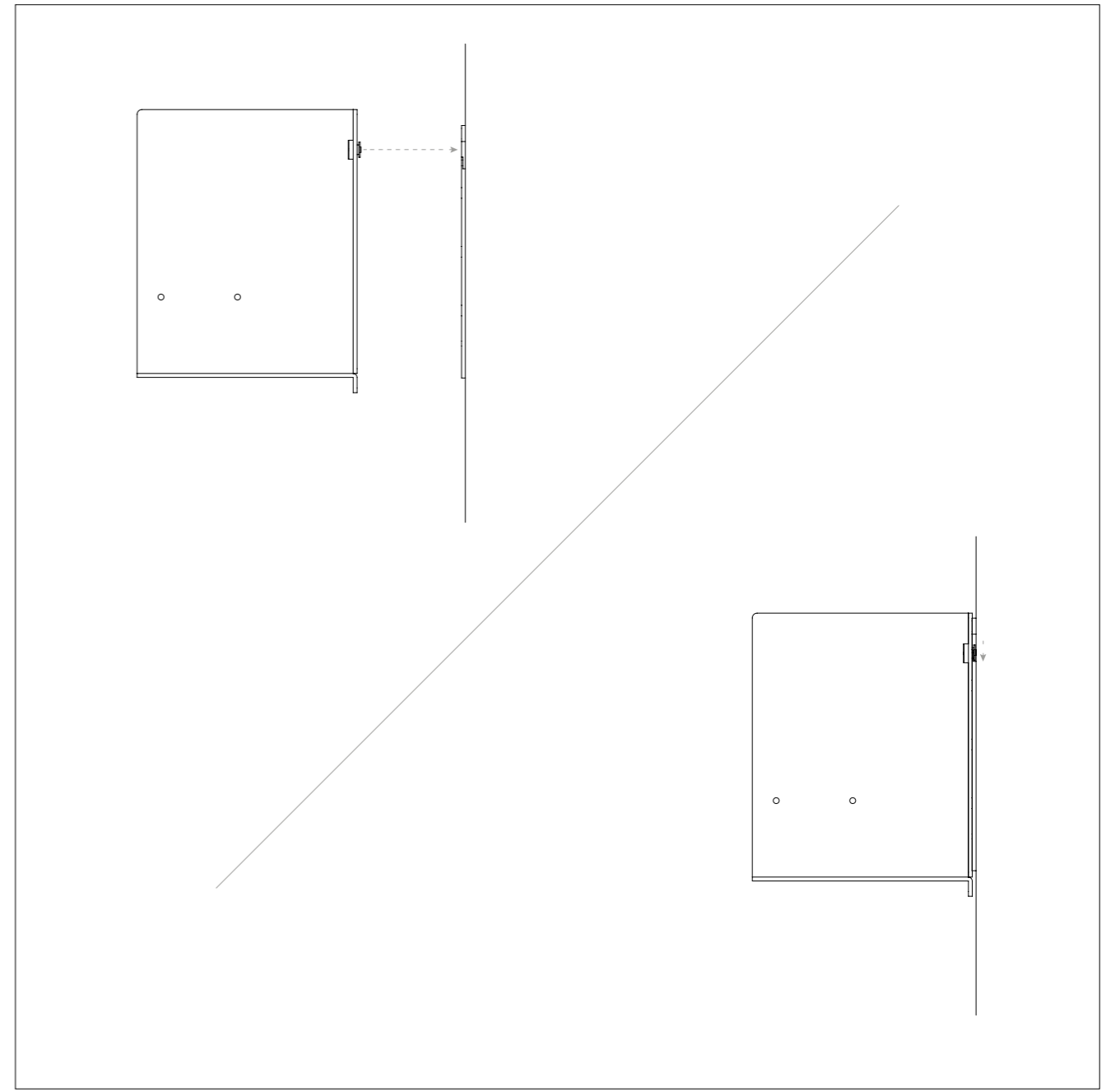
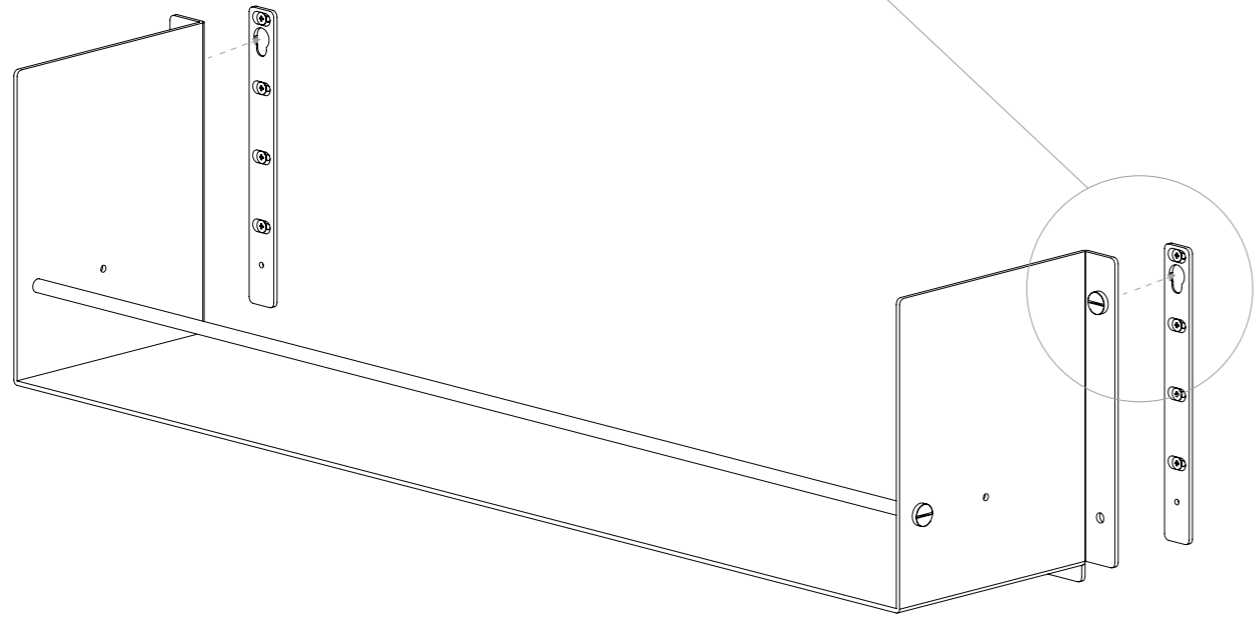

6

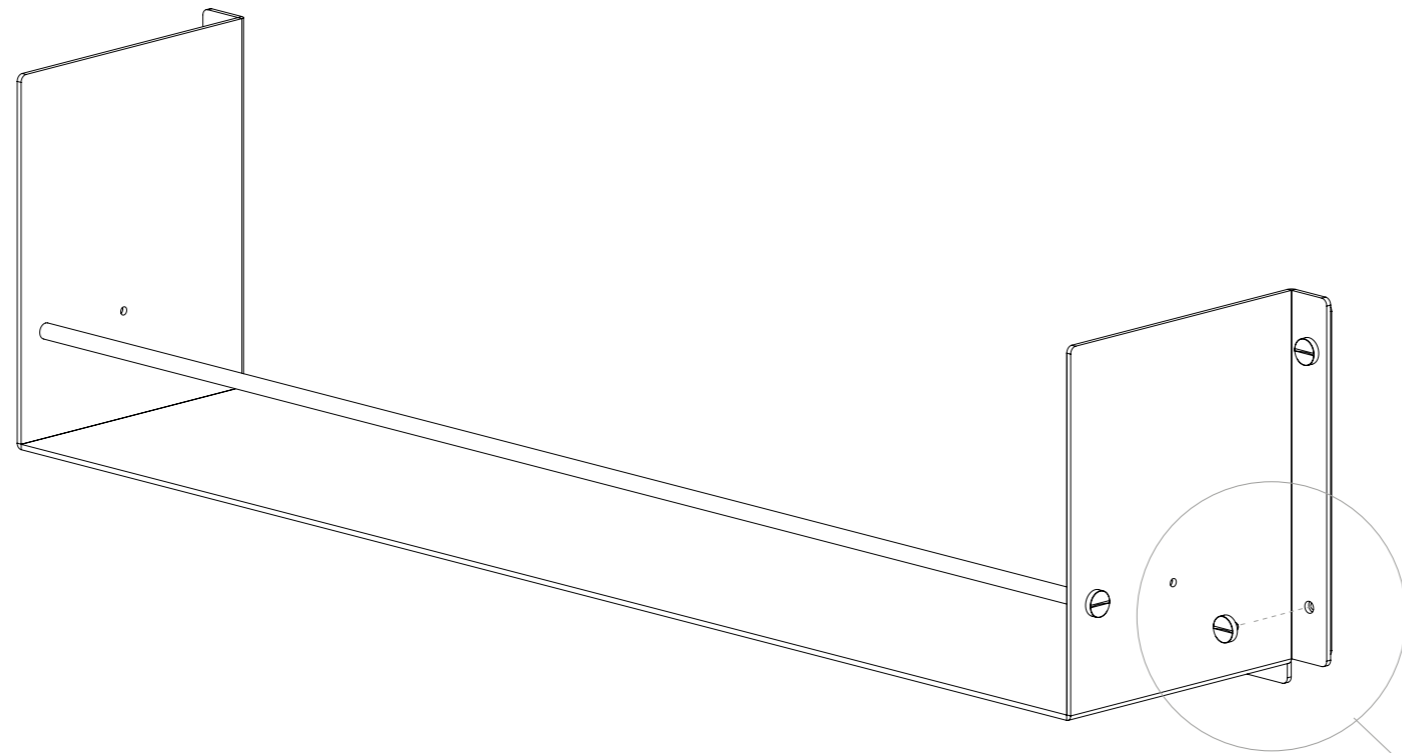
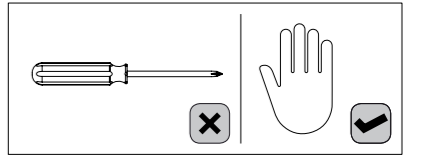

Hang the shelf on the brackets.

Use the coin screw connector and slot the shelf into the brackets.

Once the connector is in the hole, the shelf should drop down into the slot on the bracket.

