

VERSALIFT

Design R&D ASA

Introduciamo con orgoglio la nostra innovativa torretta a scomparsa Versalift, con un diametro di soli 80mm, garantendo un'eccellenza di design e funzionalità.

Certificata IP54, questa soluzione unisce con maestria stile italiano minimalista e prestazioni avanzate.

Grazie al suo design accattivante non solo si integra armoniosamente nella vostra area di lavoro, ma offre anche un'apertura e chiusura ammortizzata, conferendo un tocco di raffinatezza all'esperienza d'uso.

Introducing with pride our innovative concealed tower, Versalift, with a diameter of only 80mm, ensuring excellence in design and functionality. Certified IP54, this solution masterfully combines Italian minimalist style with advanced performance.

Thanks to its captivating design, it not only seamlessly integrates into your workspace but also provides a cushioned opening and closing, adding a touch of sophistication to the user experience.





Le finiture di pregio riflettono la nostra dedizione alla qualità, garantendo una durata nel tempo senza compromessi. Questa torretta non è solo un elemento funzionale, ma un complemento elegante che arricchisce il vostro spazio cucina con praticità e stile, perfetto per soddisfare le esigenze degli amanti della cucina moderna.

The high-quality finishes reflect our commitment to excellence, ensuring long-lasting durability without compromise. This tower is not only a functional element but also an elegant addition that enhances your kitchen space with both practicality and style, ideal for meeting the needs of modern culinary enthusiasts.







VersaLift può essere equipaggiata con un sistema di ricarica wireless per i dispositivi mobili. E' compatibile con tecnologia Qi che è la più diffusa sul mercato globale.

VersaLift can be equipped with a wireless charging system for mobile devices. It is compatible with Qi technology, which is the most widely used in the global market.





VersaLift è una multipresa certificata IP54, che garantisce a sportelli chiusi la protezione dagli spruzzi d'acqua e dall'ingresso di polvere.

VersaLift is an IP54-certified multi-socket outlet that guarantees protection from water and dust when covers are closed.



DATI TECNICI | TECHNICAL DATA

FINITURE | FINISHES

Profilo | Profile



Nero | Black

Coperchio | Top



Acciaio Spazzolato | Brushed Steel



Nero Spazzolato | Brushed black



Peltro | Pewter



Bianco Opaco | Matt White



Rame | Copper

Coperchio Wireless Charger | Wireless Charger Top



Metacrilato nero | Black methacrylate



Metacrilato bianco | White methacrylate

VERSIONI | VERSIONS

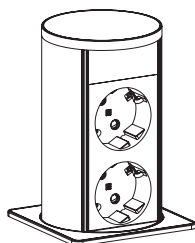

2 Sockets

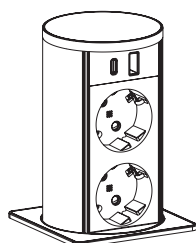

2 Sockets + USB

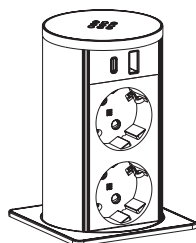

2 Sockets + USB + Wireless Charger

DIMENSIONI | DIMENSIONS (mm)

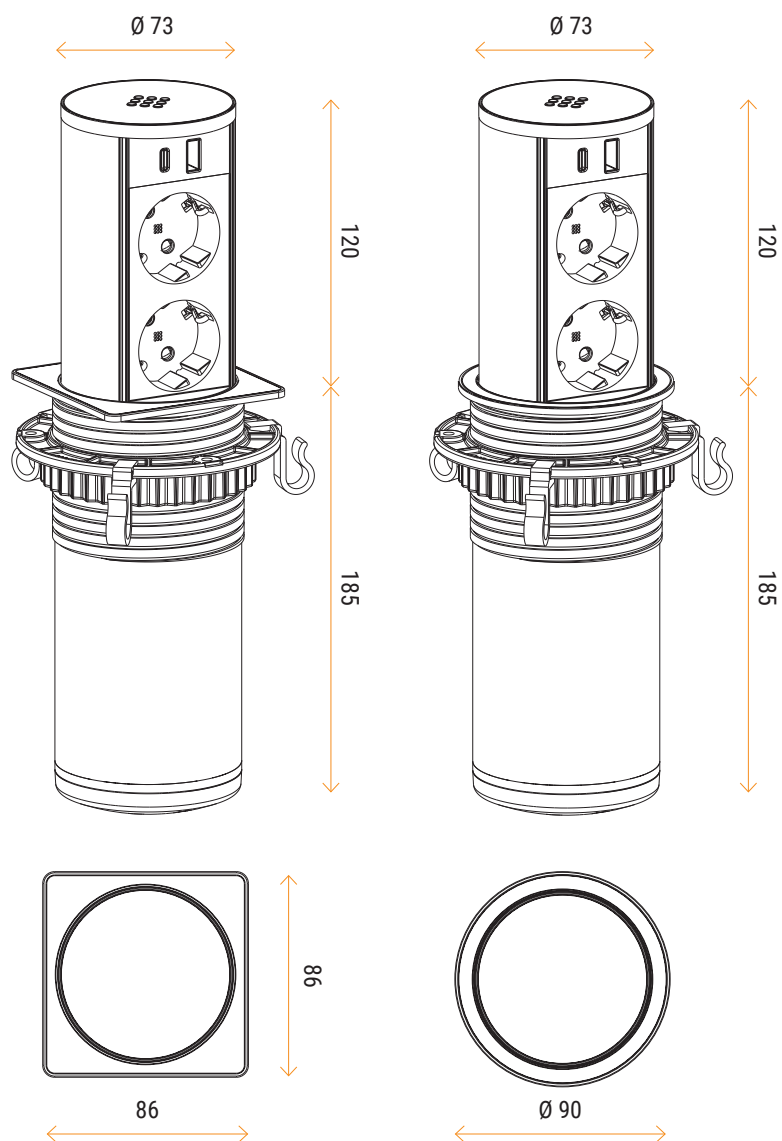

CARATTERISTICHE | KEY POINTS

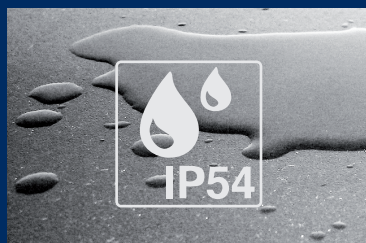

■ CERTIFICAZIONE IP54

La torretta VersaLift è protetta da infiltrazioni di polvere e acqua, garantendo resistenza alle particelle solide e protezione dagli schizzi d'acqua, ideale per ambienti umidi e polverosi.

IP54 CERTIFICATION

VersaLift is protected from dust and water, providing resistance to solid particles and protection against water splashes, ideal for kitchen countertops or break areas.



■ DOPPIA VERSIONE

Disponibile in versioni tonda e quadrata, VersaLift offre flessibilità nell'integrazione estetica in varie configurazioni di design e architettura, mantenendo alte prestazioni e praticità.

DUAL VERSION

Available in both round and square versions, VersaLift offers flexibility in aesthetic integration in various design and architectural configurations, while maintaining high performance and practicality.

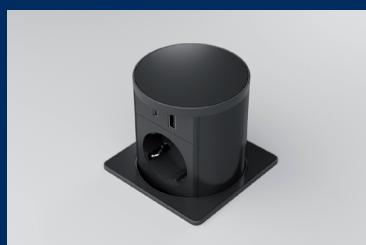

■ APERTURA E CHIUSURA AMMORTIZZATA

Grazie a un sistema innovativo, l'apertura e la chiusura della torretta avvengono in modo delicato e silenzioso, migliorando l'esperienza utente.

SOFT-CLOSE OPENING AND CLOSING

Thanks to an innovative system, the tower's opening and closing occur gently and quietly, enhancing the user experience.

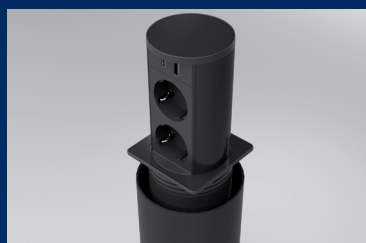

■ INSTALLAZIONE NELLE GAMBE DA 100mm

Progettata per adattarsi alle gambe dei tavoli con diametro 100 mm, VersaLift offre un accesso comodo alle prese elettriche e alle porte USB direttamente dal tavolo, mantenendo l'ambiente ordinato.

100mm ROUND SUPPORT

Designed to fit into table legs with a 100mm diameter, VersaLift provides convenient access to power outlets and USB ports directly from the table, keeping the environment neat.



■ FACILITÀ DI MONTAGGIO

VersaLift può essere rapidamente installata senza viti, grazie al sistema Plug&Play che la rende subito utilizzabile dopo l'installazione.

EASY INSTALLATION

VersaLift can be quickly installed without screws, thanks to the Plug&Play system that makes it immediately usable after installation.



■ CERTIFICATO Qi

Utilizza lo standard di ricarica wireless Qi, garantendo una trasmissione sicura e standardizzata di energia attraverso l'induzione elettromagnetica, preservando la batteria degli smartphone.

Qi CERTIFIED

It uses the Qi wireless charging standard, ensuring safe and standardized transmission of energy through electromagnetic induction, preserving smartphone battery life.